

ZYRIS™
Smiles all around.

Instructions For Use

CONTENTS

- 03 Device Description
- 06 Accessories
- 10 Intended Use
- 12 Installation
- 17 How to Operate
- 28 Disinfection, Cleaning, and Sterilization
- 30 Maintenance
- 34 Warnings
- 36 Precautions
- 40 Guide to Symbols
- 41 Limited 1-Year Warranty

DEVICE DESCRIPTION



Isolite 3 Illuminated Dental Isolation System

REF EIL0301

The Isolite 3 system is intended to be used with the single-use, non-sterile Zyris Mouthpieces. The Mouthpiece is available in a wide range of sizes for effective isolation.

Each Isolite 3 System is comprised of three main components: (1) Control Head Hose, (2) Vacuum Light Pipe, and (3) Power Vacuum Base.

Control Head Hose

REF PIL0301 (1.50 m / 59 in)

The Control Head Hose (CHH) consists of an

integrated Control Head, suction tube, and twist-lock tail connection. The Control Head includes two Vacuum Levers to adjust suction in the upper and lower areas of the Mouthpiece, buttons to control the LED light source (on/off, white and amber color output) and its three levels of brightness, plus an integrated handle. The suction tube delivers both power and vacuum from the tail connection and the Power Vacuum Base (PVB) to the Control Head. See below for cleaning and disinfection instructions.

Power Vacuum Base

REF PIL0302

The Power Vacuum Base connects to the vacuum canister, which allows for suction control to the Isolite 3 device, an accessory

port or both. The suction can also be shut off for maintenance and cleaning of the Power Vacuum Base. An indicator light illuminates red to alert the user if an error has occurred. For example, an incorrect power adapter has been plugged into the system. See below for cleaning and disinfection instructions.

Vacuum Light Pipe

REF PIL0303

The Mouthpiece attaches onto the Vacuum Light Pipe. The Vacuum Light Pipe provides dual channel suction and delivers the white and amber light into the Zyris Mouthpiece. See below for cleaning and sterilization instructions.

Power Supplies

REF PIL0304 (Power Adapter, 12VDC – 1 Amp)

REF PIL0305 (Power Terminal Cable, 24VAC – 1Amp)

The power supply delivers electrical power to the Control Head Hose via the Power Vacuum Base. Optional power supplies included with the system can be connected to a standard 110v wall plug or integrated into a dental chair's 24VAC power source.

ACCESSORIES

Cleaning Tip

REF PIL0307

The cleaning tip attaches to the control head and allows for connection to either a chairside integrated suction line cleaning system or a portable cleaning canister.

Control Head Hose O-Ring Maintenance Kit

REF AIL0239

The Control Head Hose O-Ring Maintenance Kit includes o-rings for the left and right levers, a tail connection, and Dow 111 silicone grease.

Power Vacuum Base O-Ring Maintenance Kit

REF AIL0241

Sold Separately

The Power Vacuum Base O-Ring Maintenance Kit includes o-rings for the valve dial and accessory connectors, a valve dial seal, and Dow 111 silicone grease.

Double End Tube Brush

REF AIL0204

This two-in-one cleaning brush has bristles made of sturdy nylon fiber and a flexible

plastic stem, which allows for the removal of biomatter and other debris from the suction channels.

Dow 111 Lubricant, Squeeze Tube

REF AIL0221

Sold Separately

For the o-rings to operate at peak efficiency, regularly lubricate them with Dow 111 Lubricant. This heavy-consistency dimethyl silicone compound resists a variety of organic and inorganic chemicals.

Barrier Sleeves

REF AIL0203 (non-sterile)

Sold Separately

Non-sterile Control Head Barrier Sleeves are

available for additional protection from cross-contamination. Use of Barrier Sleeves does not eliminate the need to follow disinfecting and sterilization recommendations for the Control Head Hose and Vacuum Light Pipe.

Mouthpiece

REF CILXX0X (non-sterile)

Sold Separately

The non-sterile Mouthpiece is single use only and available in various sizes. The Mouthpiece is constructed of a soft, flexible polymer for patient comfort. The Mouthpiece is free of BPA's, phthalates and does not contain natural rubber latex. For more information on sizes, go to zyris.com.

INTENDED USE

Isolite 3 is an illuminated dental isolation system for clinical use by dental professionals. The system was designed with the patient and clinician in mind. The Mouthpiece offers a soft, flexible bite block for patient comfort while providing intra-oral illumination, continuous suction, retraction of the tongue and cheek, and isolating two quadrants for the clinician. The retraction and continuous suction are the important functions that control the oral environment, reducing contamination and improving bond strength while protecting the airway and soft tissue.

Contraindications

There are no known contraindications. Do

not use without reviewing how to select the correct Mouthpiece size for each patient. Do not use if unable to position the Mouthpiece correctly.

Side Effects

Use of the Mouthpiece may trigger a pharyngeal reflex (laryngeal spasm) in hypersensitive patients or if it is not placed correctly within the oral cavity. Contact Zyris for additional placement information if needed.

How Supplied

Isolite 3

The Isolite 3 System contains: Control Head Hose, Power Vacuum Base, six Vacuum

Light Pipes, two Power Supply options, Accessory Kit and Instructions for Use.

Accessories: Cleaning Tip, 6" (trim to length) Vacuum Connector Hose, Double End Tube Brush, and Control Head Hose O-Ring Maintenance Kit.

Mouthpieces

Mouthpieces come in convenient 10-pack boxes. Each non-sterile Mouthpiece is individually packaged in a polyethylene bag. Mouthpieces come in six different sizes for varying patient needs. See Figure 3.

INSTALLATION

Isolite 3 was designed to install easily in most dental operatories (Figure 1).

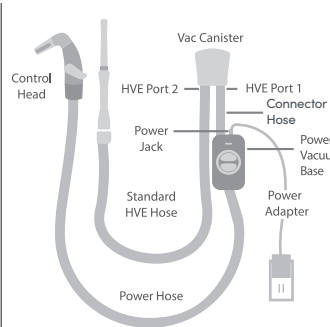

Figure 1. Installation

Installation and usage instructions, including a video demonstration, are also available at zyris.com/success.

Suction Canister With Available HVE Port

Step 1 Attach the end of the vacuum connector hose to the chair suction port.

Step 2 Place the Control Head Hose on an empty slot on the tool bar.

Step 3 Connect the Power Vacuum Base onto the vacuum connector hose.

Step 4 Plug in the power adapter to a standard 120V wall power source or have a chair technician hardwire using the supplied direct-to-chair connection cable.

Step 5 Plug in the electrical connector to the top of the Power Vacuum Base.

Step 6 Confirm the light on the Power Vacuum Base is solid blue. Refer to "Using the Power Vacuum Base LED Indicator" section in the IFU if the light is not solid blue.

Step 7 Rotate the suction selection dial to the desired setting.

Suction Canister Without Available HVE Port

Step 1 Unscrew the black screw cap from the PVB accessory port.

Step 2 Screw the provided hose barb into the PVB accessory port.

Step 3 Remove existing HVE tubing from the chair suction port.

Step 4 Attach the end of the vacuum connector hose to the chair suction port.

Step 5 Place the Control Head Hose in an empty slot on the tool bar.

Step 6 Connect the Power Vacuum Base onto the vacuum connector hose.

Step 7 Plug in the power adapter to a standard 120V wall power source or have a chair technician hardwire using the supplied direct-to-chair connection cable.

Step 8 Plug in the electrical connector to the top of the Power Vacuum Base.

Step 9 Confirm the light on the Power Vacuum Base is solid blue. Refer to "Using the Power Vacuum Base LED Indicator"

section in the IFU if the light is not solid blue.

Step 10 Rotate the suction selection dial to the desired setting.

Step 11 Rotate the dial to "All" to enable suction for the Isolite 3 and an attached HVE.



HOW TO OPERATE

Using the Dual Vacuum Levers

Dual Vacuum Levers adjust suction intensity in both the upper and lower quadrants. To adjust suction, rotate the levers to the desired suction intensity. To shut off suction, rotate the levers to the most downward position.

Using the Control Head LED Controls

Table 1. Control Head LED Status

Operation	Action
Turn light on	Tap Light Button once 
Set brightness, when on only	Tap Light Button to cycle through brightness levels
Set color output, when off or on	Tap Color Button to cycle between white and amber 
Turn light off	Press and hold Light Button

Adjust lighting functions by using the two-button light control.

The LED Control Buttons feature LED indicators that show the status of the control head.





Table 2. Control Head

LED Indicator	Status
Light Button indicator LEDs 1, 2 and 3	Light output set to level 1, 2 or 3
Light Button indicator LEDs pulse	Self-regulating temperature control has automatically lowered the brightness to reduce heat output
Color Button indicator white	White LED set
Color Button indicator amber	Amber LED set
Color Button indicator red	Auto shutdown due to over temperature. Device ready to restart when red indicator extinguishes.

Using the Suction Selection

The PVB has a three-way valve to adjust suction for your specific chair configuration.

Table 3. PVB Icons

Icon	Function
	Isolite 3 Only
	Isolite 3 + Accessory
	Accessory Only
	Off

Decreased suction may occur when Isolite 3 and Accessory are both in use.

Using The Power Vacuum Base LED Indicator

The LED indicator shows the status of the PVB.

Table 4. PVB LED Status

LED Indicator	Status
Red	Error
Blue	Power to Power Vacuum Base, Control Head Hose connected
Green	Power to Power Vacuum Base, Control Head Hose not connected

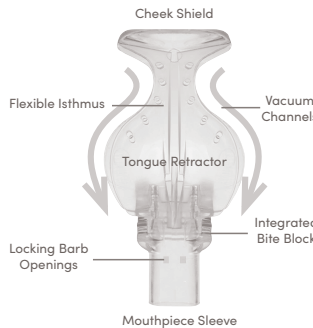

Figure 2. Mouthpiece

Selecting the Mouthpiece

To select the correct Mouthpiece size, measure the patient's interincisal opening using your fingers or the Boley Gauge. If between sizes, select the smaller size.

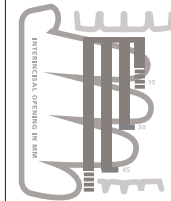

Figure 3. The Finger Method

- Pediatric / Extra Small
One Finger (< 30mm)
- Small
Two Fingers (30mm)
- Medium / Medium DV
Three Fingers (30–45mm)
- Large
Four Fingers (> 45mm)

Table 3. Mouthpiece Sizes

Mouthpiece Size	Approx. Interincisal opening
Pediatric (PED)	< 30mm
Extra Small (XSM)	< 30mm
Small (SML)	30mm
Medium (MED)	30–45mm
Medium Deep Vestibule (MDV)	30–45mm
Large (LRG)	> 45mm

Mouthpiece Sizing Method

Use your fingers or the Boley Gauge to select the appropriate Mouthpiece size (Figure 3).

For additional assistance, watch a video demonstration online at zyris.com.

Attaching the Non-sterile Mouthpiece

Slide the Mouthpiece onto the Vacuum Light Pipe until the two locking barbs engage. Water may be used to lubricate the inside surface of the Mouthpiece sleeve to ease attachment.

Placing the Mouthpiece

Prior to placing the Mouthpiece within the patient's oral cavity, moisten the Mouthpiece and the patient's lips.

Step 1 Hold the sides of the Control Head with your index finger and thumb. With your other hand, fold the Cheek Shield onto the



Step 1



Step 2



Step 3

Figure 4, 5, & 6. Mouthpiece Placement

Tongue Retractor. Gently slide the folded Mouthpiece into the buccal vestibule on the side to receive treatment. Angle the Mouthpiece to allow the lower edge of the Tongue Retractor to move along the buccal edge of the teeth.

Step 2 Move the bite block onto the occlusal surface of the teeth, just distal to the mandibular cuspid. Instruct the patient to "rest gently" on the bite block to secure.

Step 3 Place the Cheek Shield into the buccal vestibule. Move the Isthmus onto the retromolar pad behind the maxillary tuberosity. Adjust the Tongue Retractor in the lingual vestibule as needed. Move the bite block distally to provide more vertical working room.

DISINFECTION, CLEANING AND STERILIZATION

Surface Disinfection of the Control Head Hose

Zyris recommends performing a surface disinfection of the Control Head Hose between each patient. To disinfect the Control Head Hose, first remove the Vacuum Light Pipe.

Following the manufacturer's instructions for contact time, use an intermediate level disinfectant wipe with a claim to inactivate Mycobacterium tuberculosis. Otherwise, use a hospital grade disinfectant on all surfaces of the Control Head and the Control Head Hose to remove all visible biomatter and debris.

Do not submerge the Control Head Hose.

Cleaning and Sterilization of the Isolite 3 Vacuum Light Pipe

Zyris recommends sterilization of the Isolite 3 Vacuum Light Pipe between each patient.

Table 4. Validated Sterilization Cycles

Cycle	Temperature	Minimum Exposure Time	Minimum Drying Time
Standard	121 °C / 250 °F	30 min	30 min
Standard	126 °C / 259 °F	10 min	30 min
Standard	132 °C / 270 °F	15 min	15 min
Prevacuum	132 °C / 270 °F	4 min	20 min
Prevacuum	134 °C / 273 °F	3 min	20 min

Remove biomatter and other debris from the suction channels using a brush with a neutral pH (6.5-7.5) enzymatic cleaning solution. Do not use solution to hold parts. After cleaning, rinse with tap water, dry and place components in an autoclave pouch to be sterilized in a steam autoclave. Use validated sterilization cycles (Table 4).

MAINTENANCE

Control Head Hose and Power Vacuum Base Internal Surfaces

Cleaning the inside of the Control Head Hose and Power Vacuum Base regularly is needed to prevent the accumulation of biofilm. To clean the inside of the Control Head Hose and Power Vacuum Base, first

remove the VLP if attached and connect the Cleaning Tip to the Control Head. Next, attach the end of the cleaning tip to a portable or chairside cleaning canister. Actuate the suction levers by drawing the dental hose cleaner through the hose per the manufacturer's instructions. The vacuum hose cleaner should be nonfoaming, deodorizing, antimicrobial, and able to dissolve organic debris. Most enzymatic cleaners with a pH between 6 and 8 are acceptable. If further disinfection is necessary, consult your vacuum manufacturer for recommendations. When complete, remove the Cleaning Tip and place in an autoclave bag for storage until the next cleaning. Control Head Hose Levers must be in place during the suction of cleaning fluid.

Control Head Hose Levers

The Vacuum Lever o-rings require weekly lubrication to operate at peak efficiency. Before removing the levers, rotate the dial on the Power Vacuum Base to the "X" to shut off the suction. To remove the Vacuum Levers, push the levers to the "on" position and keep pushing gently until each lever pops out or gently pry them out. Apply Dow 111 Lubricant supplied in the O-Ring Maintenance Kit to the o-ring.

Reattach the Vacuum Levers to the Control Head Hose.

Power Vacuum Base

The Power Vacuum Base Dial may require cleaning, depending on the frequency of

use. To remove the dial, rotate clockwise past the "X" position to the eject "▲" position and pull it out of the Power Vacuum Base. Remove biomatter and other debris from the dial and suction channels using a brush with a neutral pH (6.5-7.5) enzymatic cleaning solution. After cleaning, rinse with tap water, dry and replace the dial.

The Power Vacuum Base dial o-ring may require lubrication, depending on the frequency of use. To remove the dial, rotate clockwise past the "X" position to the eject "▲" position and pull it out of the Power Vacuum Base. Apply the Dow 111 Lubricant supplied in the O-Ring Maintenance Kit to the o-ring. Re-insert the dial to the Power Vacuum Base. The central suction system

should be turned off to remove dial for maintenance or open the HVE tip to relieve the suction from the dial.

WARNINGS



⚠️WARNING: Shock hazard if incorrect power supply is used. Only use the power supplies provided with your Isolite 3 device. Use of other power sources may damage electronics and voids your product warranty. The Power Vacuum Base power input requirement is 12 VDC / 24VAC, 1.0 amp.

⚠️WARNING: Mouthpieces are single use only. Re-use can result in the transmission of infectious pathogens. Mouthpieces must be

discarded after use. Mouthpieces cannot be safely resterilized after use.

⊗WARNING: Do not use if the individual Mouthpiece package has been damaged or opened.

⚠️WARNING: Be sure to use established protocols and patient monitoring when using the Mouthpiece in conjunction with sedation dentistry. Patient management by a certified anesthesiologist is strongly recommended.

PRECAUTIONS

⚠CAUTION: When performing dental procedures requiring high levels of blood evacuation, it is recommended that the Mouthpiece be intermittently flushed with water to prevent coagulation in the Mouthpiece to avoid loss of suction and light transmission.

⚠CAUTION: With regular use, cleaning, and maintenance, the device is designed to last for years. Check the device for wear prior to use to make sure that it is adequate for use.

⚠CAUTION: Do not block access to the Power Adapter. The Power Adapter should be easily accessible so that it can be unplugged from the wall outlet if necessary.

⚠CAUTION: To avoid electrical shock, the use of an extension cord with the Power Adapter is not recommended.

⚠CAUTION: Do not crimp or fold the Power Hose to shut off suction. Internal damage to the Power Hose wiring may occur.

⚠CAUTION: The Control Head Hose and Power Vacuum Base contain sensitive electronics and require special care and handling. Do not submerge, autoclave, chemclave or place in ultrasonic cleaner.

⚠CAUTION: Do not autoclave the Vacuum Light Pipe at temperatures above 135 °C; higher temperatures could damage components and void your product warranty.

⚠CAUTION: Do not hold Control Head

Hose or Power Vacuum Base in cleaning solution or use ultrasonic cleaners.

⚠CAUTION: Failure to maintain properly lubricated o-rings can result in damage to the Isolite 3 device that is not covered by product warranty.

⚠CAUTION: This device complies with Part 15 of the FCC rules. Operation is subject to the following two conditions: (1) this device may not cause harmful interference, and (2) this device must accept any interference received, including interference that may cause undesired operation.

DATA COLLECTION

Zyris would like your help improving the quality of our products by automatically collecting and sending anonymous usage data from your Isolite 3 to Zyris.

Usage data collected includes internal temperature, device position, light color, and light level. No patient or account information is recorded or transmitted.

Zyris does not share this information with any third parties under any circumstances.

If you would prefer to opt-out of sending usage data from your device, please visit Zyris.com/i3-optout.

GUIDE TO SYMBOLS



Non-sterile



Caution



Do not re-use



Positive polarity



Consult Instructions for Use



Do not use if package is damaged



Type B applied part electrical hazard



Date of manufacture



Manufacturer



Catalog number

LIMITED 1-YEAR WARRANTY

Zyris warrants this product to be free from defects in material and workmanship for a period of one year from the date of original purchase. If the product exhibits such a defect, Zyris will, at its option, repair or replace it without costs for parts and labor. The product must be returned by the customer to Zyris in accordance with current Return Material Authorization procedures. Proof of date of original purchase may be required. This warranty does not cover finishes or normal wear, nor does it cover damage resulting from accident, misuse, dirt, tampering, unreasonable use, failure to provide reasonable and necessary maintenance, service performed or attempted by unauthorized individuals or service agencies, or devices that have been otherwise modified. All implied warranties, including any implied warranty or merchantability or fitness for any particular purpose, are limited in duration to one year from the date of receipt of the product. In no event will Zyris be responsible for consequential damages resulting from the use of this product.

Instructions for Use may also be found at: zyris.com/success

Zyris™, Inc.
6868A Cortona Drive
Santa Barbara, CA 93117

Phone +1 (805) 560-9888
Fax +1 (805) 966-6416
In the USA, toll free:
1-800-560-6066
www.zyris.com

© 2018 Zyris™, Inc.
All rights reserved.
Patent Information
www.zyris.com/patents